



User Manual

Sigma 05

Sensor Hub/Modular Sensor Platform

YOUR PARTNER IN SENSOR TECHNOLOGY



ELEKTRONIK[®]
Ges.m.b.H.

E+E Elektronik Ges.m.b.H. does not accept warranty and liability claims neither upon this publication nor in case of improper treatment of the described products.

The document may contain technical inaccuracies and typographical errors. The content will be revised on a regular basis. These changes will be implemented in later versions. The described products can be improved and changed at any time without prior notice.

© Copyright E+E Elektronik Ges.m.b.H. All rights reserved.

EMC note USA (FCC):

This equipment has been tested and found to comply with the limits for a Class A digital device, pursuant to part 15 of the FCC Rules. These limits are designed to provide reasonable protection against harmful interference when the equipment is operated in a commercial environment. This equipment generates, uses, and can radiate radio frequency energy and, if not installed and used in accordance with the instruction manual, may cause harmful interference to radio communications. Operation of this equipment in a residential area is likely to cause harmful interference in which case the user will be required to correct the interference at his own expense.

EMC note Canada (ICES-003):

CAN ICES-3 (A) / NMB-3 (A)

CONTENT

1	General	4
1.1	Explanation of Symbols	4
1.2	Safety Instructions	4
1.2.1	General Safety Instructions	4
1.2.2	Intended Use	4
1.2.3	Mounting, Start-up and Operation	5
1.3	Environmental Aspects	5
2	Scope of Supply	5
3	Product Description	5
3.1	General	5
3.2	Dimensions	6
3.3	Device Mounting	6
3.4	Electrical Connection	6
3.5	Sensing Probes	7
3.5.1	Sigma Plug-and-Play	7
3.5.2	Sigma Compatible E+E Probes and Sensors	7
3.6	Probe Interface: RS485 with Modbus RTU Protocol	8
3.7	Electronics Board	8
3.8	LED Array Indication	9
3.9	Display Functionality	9
3.9.1	Power Up, Scan	9
3.9.2	Normal Operation	10
3.9.3	Configuration	10
4	Plug-and-Play Operation / Setup	11
	The standard proceeding for starting plug-and-play operation:	11
5	Manual Operation / Setup	13
6	Maintenance and Service	13
6.1	Display Change and Retrofitting	13
6.2	Firmware Update	14
6.3	Reference Probe	14
6.4	Repairs	14
6.5	Error Indication on the Analogue Output (NAMUR)	14
7	Spare Parts	14
8	Technical Data	15

1 General

This user manual serves for ensuring proper handling and optimal functioning of the device. The user manual shall be read before commissioning the equipment and it shall be provided to all staff involved in transport, installation, operation, maintenance and repair. The user manual may not be used for the purposes of competition without the written consent of E+E Elektronik and may not be forwarded to third parties. Copies may be made for internal purposes. All information, technical data and diagrams included in these instructions are based on the information available at the time of writing.

Disclaimer

The manufacturer or his authorized agent can be only be held liable in case of willful or gross negligence. In any case, the scope of liability is limited to the corresponding amount of the order issued to the manufacturer. The manufacturer assumes no liability for damages incurred due to failure to comply with the applicable regulations, operating instructions or the specified operating conditions. Consequential damages are excluded from the liability.

1.1 Explanation of Symbols



This symbol indicates safety information.

It is essential that all safety information is strictly observed. Failure to comply with this information can lead to personal injuries or damage to property. E+E Elektronik assumes no liability if this happens.



This symbol indicates instructions.

The instructions shall be observed in order to reach optimal performance of the device.

1.2 Safety Instructions

1.2.1 General Safety Instructions

- The Sigma 05 and the sensing probes connected shall not be exposed to unnecessary mechanical stress.
- The Sigma05 electronics is sensitive to electrostatic discharge (ESD), appropriate protective measures should be taken when touching it.
- Handle the sensing probes employed with Sigma 05 according to their respective user manuals.
- Installation, electrical connection, maintenance and commissioning shall be performed by qualified personnel only.
- Use the Sigma 05 only as intended and observe all technical specifications.
- Do not use Sigma 05 in explosive atmosphere or for measurement of aggressive gases.
- Do not apply the nominal voltage to the RS485 data lines.
- This device is not appropriate for safety, emergency stop or other critical applications where device malfunction or failure could cause injury to human beings.

1.2.2 Intended Use

The Sigma 05 is a sensor hub for up to 3 E+E probes. Depending on the probes, Sigma 05 can be employed in most various industries and applications. The sensing probes can be connected directly to the host device or via M12 cables. Refer to chapter 3.5 for details on the “Sigma plug-and-play” and the “Sigma compatible” probes.

The use of the Sigma 05 in any other way than described in this manual bears a safety risk for people and the entire measurement installation and is therefore not allowed.

The manufacturer cannot be held responsible for damages as a result of incorrect handling, installation, and maintenance of the device.

In order to avoid damage to the device or health hazards, the device may not be manipulated with tools other than specifically described in this manual.

The Sigma 05 may only be utilized in accordance with the stipulations of the present user manual and the specification in chapter 8 Technical Data. Otherwise, measurement inaccuracy might occur and failures cannot be ruled out.

1.2.3 Mounting, Start-up and Operation

The Sigma 05 sensor hub has been produced under state of the art manufacturing conditions, has been thoroughly tested and has left the factory after fulfilling all safety criteria. The manufacturer has taken all precautions to ensure safe operation of the device. The user must ensure that the device is set up and installed in a manner that does not have a negative effect on its safe use. The user is responsible for observing all applicable safety guidelines, local and international, with respect to safe installation and operation of the device. This user manual contains information and warnings that must be observed by the user in order to ensure safe operation.



- Mounting, start-up, operation and maintenance of the device may be performed by qualified staff only. Such staff must be authorized by the operator of the facility to carry out the mentioned activities.
- The qualified staff must have read and understood this user manual and must follow the instructions contained within.
- All process and electrical connections shall be thoroughly checked by authorized staff before putting the device into operation.
- Do not install or start-up a device supposed to be faulty. Make sure that such devices are not accidentally used by marking them clearly as faulty.
- A faulty device may only be investigated and possibly repaired by qualified, trained and authorized staff. If the fault cannot be fixed, the device shall be removed from the process.
- Service operations other than described in this user manual may only be performed by the manufacturer.

1.3 Environmental Aspects



Products from E+E Elektronik are developed and manufactured in compliance with all relevant environmental protection requirements. Please observe local regulations for the device disposal.



For disposal, the individual components of the device must be separated according to local recycling regulations. The electronics shall be disposed of correctly as electronics waste.

2 Scope of Supply

- Sigma 05 Sensor Hub according to ordering guide
- Quick Guide
- Mounting materials
- Test report according to DIN EN 10204-2.2

3 Product Description

3.1 General

The Sigma 05 is a host device acting as a hub for intelligent E+E sensors with RS485 interface and Modbus RTU protocol. It accommodates up to 3 probes and features 2 analogue outputs as well as an optional display for max. 3 measurands. The probes are pluggable and can be easily interchanged.

In its factory setting, the Sigma 05 automatically detects and recognises Sigma plug-and-play probes and performs an autonomous, rule based hub setup. Refer to chapter 4 Plug-and-Play Operation / Setup for details.

For a setup deviating from default, the Sigma 05 can be configured manually by means of the free PCS10 Product Configuration Software. Refer to chapter 5 Manual Operation / Setup for details.

The optional display features backlight and shows up to 3 measurands including the symbol of the physical quantity and the measurement unit. The font size automatically adapts to the number of lines. See chapter 3.9.2 for details. The display can be retrofitted to Sigma 05 devices that were originally ordered without a display. Refer to chapter 7 Spare Parts.

3.2 Dimensions

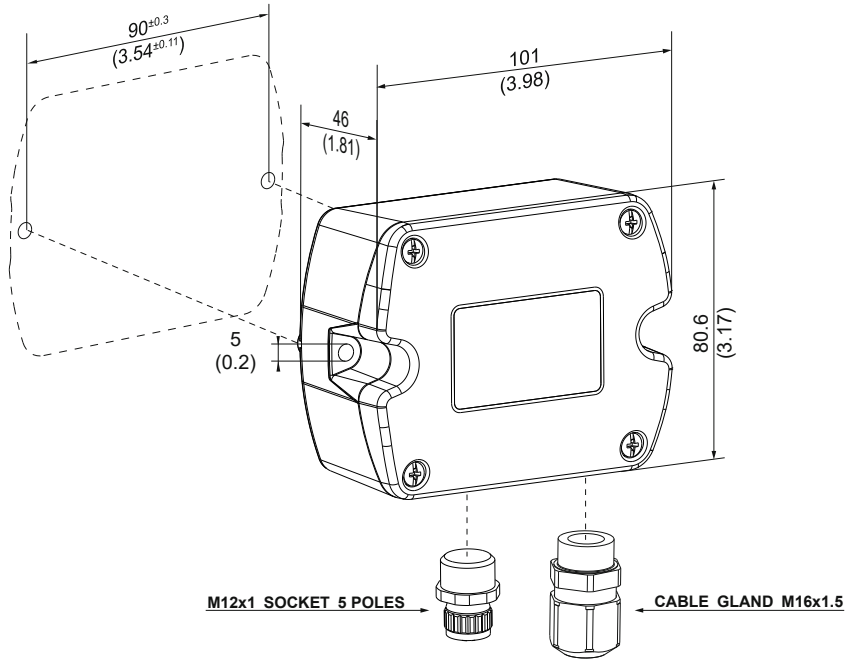

Fig. 1 Sigma 05 dimensions in mm (inch)

3.3 Device Mounting

The Sigma 05 shall be mounted onto a wall or other vertical surface, with the connectors pointing downwards.

Probes may be connected directly to the Sigma 05 or remotely via unshielded connection cables with max. 10 m (32.8 ft) length (available as accessories, see the Sigma 05 datasheet).



For long-term reliability, it is of utmost importance to employ quality extension cables with tightly cast M12 connectors.

3.4 Electrical Connection

Sigma 05 features spring clamp terminals for connecting the power supply and the analogue outputs. The cables are fed into the enclosure through the M16x1.5 cable gland.



Important note:

The manufacturer cannot be held responsible for personal injuries or damage to property as a result of incorrect handling, installation, wiring, power supply and maintenance of the device.

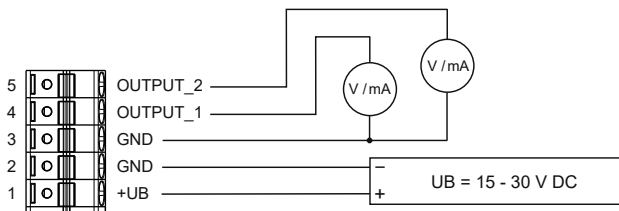
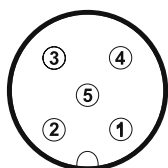

Fig. 2 Voltage supply and outputs



M12 device socket front view

Pin number	Assignment
1	Supply voltage
2	RS485 B (D-)
3	GND
4	RS485 A (D+)
5	Not connected

Tab. 1 Sigma 05 pin assignment of the sensing probe connector (RS485 / Modbus RTU protocol)



The supply voltage applied to the probes connected to the RS485 interface is always equal to the supply voltage applied to Sigma 05.



Power off Sigma 05 before connecting or disconnecting sensing probes. Failing to do so may cause damages to Sigma 05 and to the probes.



- Choose the Sigma 05 supply voltage (in the range 15 - 30 V DC) to match the probe supply requirements.
- For minimizing the self-heating and its effect onto the measurement accuracy of the RH and / or T probes, use lower supply voltage, e.g. 15 V DC. The self heating affects mostly the RH and / or T probes with metal enclosures and it is negligible for probes with pastic enclosure. Refer to the datasheet of the respective probe.



For Sigma 05 to fulfill IP65 / NEMA 4 protection rating, the cable gland for inserting the cable for supply and outputs must be tightly closed. Furthermore, the front cover of Sigma 05 must be properly closed.



Some E+E probes with both, analogue output and digital interface, feature a configuration pin (pin no. 5) to enable a configuration via the digital interface. Since the Sigma 05 makes use of the probes' digital interface per default, this pin is not connected.

3.5 Sensing Probes

3.5.1 Sigma Plug-and-Play



“Sigma Plug-and-Play“ means that Sigma 05 automatically detects the connected E+E Modbus probes at startup and performs a rule-based setup. Depending on the connected probes, a predefined set of up to 5 measurands is assigned to the analogue outputs and to the display, refer to chapter 4 Plug-and-Play Operation / Setup.

E+E Sigma Plug-and-Play Probe	Modbus address
EE072	234
EE074	233
EE671	238
EE680	68
EE872	237
HA010406	232

Tab. 2 Sigma 05 plug-and-play probes and their Modbus address

3.5.2 Sigma Compatible E+E Probes and Sensors

The “Sigma compatible” E+E probes and sensors fulfill following criteria:

RS485 Serial Communication	
Baudrate	9 600, 19 200, 38 400, 57 600, 115 200
Data bits	8
Parity	None, even, odd
Stop bits:	1, 2
Modbus RTU Protocol	
Modbus address	1...247
Function Code	03, 04
Data format	According standard IEEE754, floating point 32 bit, big-endian, word swapped.

For operation with Sigma 05 sensor hub the “Sigma compatible” probes require manual setup (see chapter 5 Manual Operation / Setup) and possibly connection adapters.



All E+E probes and sensors with RS485 interface and Modbus RTU protocol are “Sigma compatible”.

The rest of this manual deals with Sigma plug-and-play probes, unless otherwise specified.

3.6 Probe Interface: RS485 with Modbus RTU Protocol

Item	Factory settings	Selectable values
Baud rate	9 600	9 600, 19 200, 38 400, 57 600, 76 800, 115 200
Data bits	8	8
Parity	Even	None, odd, even
Stop bits	1	1, 2
Modbus address	-	Sigma 05 is Modbus master and does not have an address

Tab. 3 Interface default settings

The recommended settings for multiple devices in a Modbus RTU network are 9 600, 8, even, 1. The Sigma 05 represents 1 unit load on an RS485 network.

RS485 communication settings can be changed with PCS10 Product Configuration Software.

3.7 Electronics Board

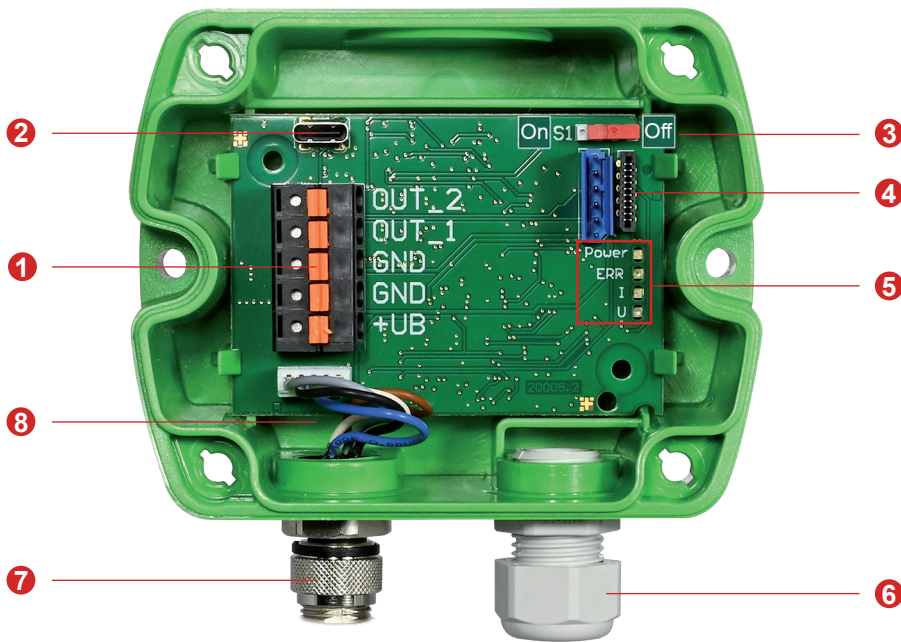



Fig. 3 Sigma 05 electronics board

No.	Function
1	Spring clamp terminals for power supply and analogue outputs
2	USB-C configuration interface
3	Slide switch for the 120 Ω RS485 network termination resistor
4	FFC cable socket for the display
5	LED array  <ul style="list-style-type: none"> Green: Power Red: Error Orange: Current outputs Blue: Voltage outputs <p>The function of each LED is outlined at chapter 3.8 LED Array Indication.</p>
6	M16 cable gland
7	M12 socket: RS485 interface and power supply for the probes
8	Data and power lines towards the probe(s)

Tab. 4 Accessible board components

3.8 LED Array Indication

LED	Behaviour
Power (green)	LED flashes every second as soon as the microcontroller of Sigma 05 is active. This indication is independent of the power source (USB or power terminals).
Error (red)	Constantly OFF: no errors detected LED flashes every second: fatal error (error code retrieval with PCS10) LED flashes shortly every two seconds: problems with Modbus probe configuration. Check the setup with PCS10 and/or the wiring.
Current outputs (orange)	Constantly ON: Two active current outputs. Constantly OFF: <ul style="list-style-type: none"> ■ Sigma 05 is USB-powered, the analogue outputs are thus disabled or ■ One output is set to voltage, the other to current.
Voltage outputs (blue)	Constantly ON: Two active voltage outputs. Constantly OFF: <ul style="list-style-type: none"> ■ Sigma 05 is USB-powered, no analogue output possible or ■ One output is set to voltage, the other to current. <p>Orange and blue LEDs constantly ON simultaneously: Automatic probe discovery active or device is starting up and has not yet activated the configuration (approx. 1 s).</p>

Tab. 5 Behaviour of on-board LED array

3.9 Display Functionality

3.9.1 Power Up, Scan

After power up in Automatic Probe Discovery mode (default setting), a progress bar made up of single points indicates Sigma 05 scanning the RS485 interface for sensing probes. A question mark appears approx. every 12 seconds as long as no probe is detected, see Fig. 4.



Fig. 4 Display during RS485 interface scan

As soon as one or more sensing probes are discovered, the display turns into normal operation.

3.9.2 Normal Operation

Depending on the number of measurands automatically or manually assigned to it, the display shows up to 3 lines with the measurand symbol, the measured value and the unit.



Fig. 5 Display layouts in normal operation

3.9.3 Configuration

If the Sigma 05 host device is connected with a PC via USB only (i. e. no voltage supply at the spring clamp terminals, see Fig. 3), the display shows the USB symbol.

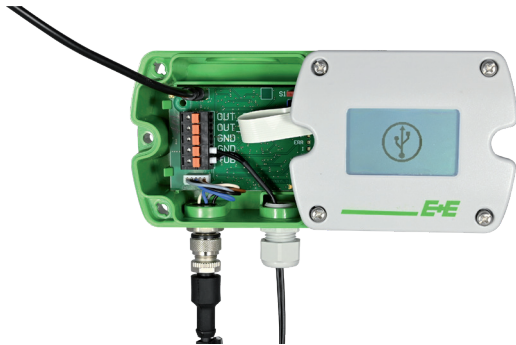

Fig. 6 Sigma 05 with USB connection active only

Measured data flashing every second indicates that the corresponding measurand got beyond the thresholds defined via PCS10.

If the communication between Sigma 05 and any sensing probe is disturbed and consequently there is no measured data available, the corresponding display lines show "--,--". See Fig. 7.



Fig. 7 Sigma 05 with interrupted communication towards sensing probe(s)

Please refer to chapter 5 Manual Operation / Setup for a comprehensive overview of the configuration options.

4 Plug-and-Play Operation / Setup

This operation mode requires Sigma plug-and-play probes according to Tab. 6. The Automatic Probe Discovery of Sigma 05 sensor hub must be enabled (default setting).

The standard proceeding for starting plug-and-play operation:

- Mount the Sigma 05
- Connect the plug-and-play sensing probes
- Power up the Sigma 05

Upon power on, Sigma 05 starts automatically the „Automatic Probe Discovery“ process by scanning the RS485 interface.

On the electronics board, auto-discovery is indicated by the flashing green LED and the orange and the blue LED constantly on, see Tab. 5.

As soon as Sigma 05 discovers at least one probe, it autonomously performs the setup according to predefined rules. By this, the display layout and the analogue outputs are automatically set according to Tab. 6.

If needed, the predefined plug-and-play setup can be subsequently altered with the PCS10 Product Configuration Software, see chapter 5 Manual Operation / Setup.

#	Probe	Analogue Output 1				Analogue Output 2				Display Line 1		Display Line 2		Display Line 3	
		Measurand	Scale SI	Scale US	Measurand	Scale SI	Scale US	SI	US	SI	US	SI	US	SI	US
1	EE072	RH	0...100%	0...100%	T	-40...80 °C	-40...176 °F	RH [%]	RH [%]	T [°C]	T [°F]				
2	EE074	T	-40...80°C	-40...176 °F				T [°C]	T [°F]						
3	EE872-M13	CO ₂	Range of probe	Range of probe	RH	0...100 %	0...100 %	CO ₂ [ppm]	CO ₂ [ppm]	RH [%]	RH [%]			T [°C]	T [°F]
4	EE872-M10	CO ₂	Range of probe	Range of probe				CO ₂ [ppm]	CO ₂ [ppm]						
5	EE671	v	Range of probe	Range of probe				v [m/s]	v [ft/min]						
6	EE680	vn	Range of probe	Range of probe	T	0...50 °C	32...122 °F	vn [m/s]	vn [ft/min]	T [°C]	T [°F]				
7	HA010406	RH	0...100%	0...100%	T	-40...180 °C	-40...356 °F	RH [%]	RH [%]	T [°C]	T [°F]				
8	EE072	RH	0...100%	0...100%				RH [%]	RH [%]						
	EE074				T	-40...80 °C	-40...176 °F			T [°C]	T [°F]				
9	EE872-M13	CO ₂	Range of probe	Range of probe				CO ₂ [ppm]	CO ₂ [ppm]						
	EE072				RH	0...100%	0...100%			RH [%]	RH [%]			T [°C]	T [°F]
10	EE872-M10	CO ₂	Range of probe	Range of probe				CO ₂ [ppm]	CO ₂ [ppm]						
	EE072				RH	0...100%	0...100%			RH [%]	RH [%]			T [°C]	T [°F]
11	EE671	v	Range of probe	Range of probe				v [m/s]	v [ft/min]						
	EE072				RH	0...100%	0...100%			RH [%]	RH [%]			T [°C]	T [°F]
12	EE680	v	Range of probe	Range of probe				vn [m/s]	vn [ft/min]						
	EE072				RH	0...100%	0...100%			RH [%]	RH [%]			T [°C]	T [°F]
13	EE872-M13	CO ₂	Range of probe	Range of probe				CO ₂ [ppm]	CO ₂ [ppm]					T [°C]	RH [%]
	EE074				T	-40...80 °C	-40...176 °F			T [°C]	T [°F]				
14	EE872-M10	CO ₂	Range of probe	Range of probe				CO ₂ [ppm]	CO ₂ [ppm]						
	EE074				T	-40...80 °C	-40...176 °F			T [°C]	T [°F]				
15	EE671	v	Range of probe	Range of probe				v [m/s]	v [ft/min]						
	EE074				T	-40...80 °C	-40...176 °F			T [°C]	T [°F]				
16	EE680	vn	Range of probe	Range of probe				vn [m/s]	vn [ft/min]						
	EE074				T	-40...80 °C	-40...176 °F			T [°C]	T [°F]				
17	EE872-M13	CO ₂	Range of probe	Range of probe				CO ₂ [ppm]	CO ₂ [ppm]					T [°C]	T [°F]
	EE671				v	Range of probe	Range of probe			v [m/s]	v [ft/min]				
18	EE872-M13	CO ₂	Range of probe	Range of probe				CO ₂ [ppm]	CO ₂ [ppm]					T [°C]	T [°F]
	EE680				vn	Range of probe	Range of probe			vn [m/s]	vn [ft/min]				
19	EE872-M10	CO ₂	Range of probe	Range of probe				CO ₂ [ppm]	CO ₂ [ppm]						
	EE671				v	Range of probe	Range of probe			v [m/s]	v [ft/min]				
20	EE872-M10	CO ₂	Range of probe	Range of probe				CO ₂ [ppm]	CO ₂ [ppm]						
	EE680				vn	Range of probe	Range of probe			vn [m/s]	vn [ft/min]			T [°C]	T [°F]
21	EE680	vn	Range of probe	Range of probe				vn [m/s]	vn [ft/min]					T [°C]	T [°F]
	EE671				v	Range of probe	Range of probe			v [m/s]	v [ft/min]				

Tab. 6 Probe combinations with automatic probe discovery

5 Manual Operation / Setup

The Sigma 05 is ready to use and does not require any configuration by the user. The Sigma 05 factory setup corresponds to the type number ordered. Please refer to the data sheet at www.epluse.com/Sigma05. The user can change the factory setup with the help of the PCS10 Product Configuration Software and the USB cable for connecting Sigma 05 to PC (HA010327).

For changing the factory setup of the sensor platform with PCS10, proceed as follows:

1. Download the PCS10 Product Configuration Software from www.epluse.com/PCS10 and install it on the PC. PCS10 requires Windows 8.1 or higher.
2. Connect the Sigma 05 to the PC using the USB connection cable.
3. Start the PCS10 software.
4. On the PCS10 opening page scan the ports and identify the connected device.
5. Click on the desired Sigma 05 hub device and disable the “Automatic probe discovery” in the “Probe settings” view.



As long as the “Automatic probe discovery” is enabled, the PCS10 only shows information on the Sigma 05 and on the connected probes, as well as the measured data in the “Live View” view. All configuration features are disabled.

6. Start configuration. Please observe the PCS10 Help dropdowns for further information.



The USB interface provides power supply to the Sigma 05 electronics only. In this case, the probes connected to Sigma 05 are not powered and consequently, the functions of the PCS10 are limited.

The limited setup functionality (for USB supply only) includes:

- Set the individual device name
- Export and import Sigma 05 configuration

For full setup functionality the Sigma 05 must be powered at the spring clamp terminals. The full setup functionality additionally includes:

- Read the measured data
- Add and assign measurands from the probes
- Add new probes
- Change the probe communication parameters
- Change the display layout
- Change the output signals
- Scale the outputs
- Set warning thresholds for the measurands on the display
- Set the error indication on the analogue outputs, see chapter 6.5.
- Perform offset and 2-point adjustment of the probes connected to Sigma 05

6 Maintenance and Service

6.1 Display Change and Retrofitting

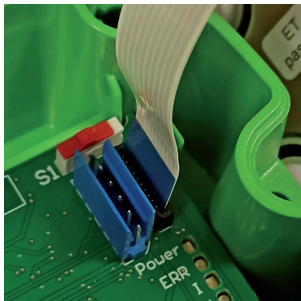

Fig. 8 FFC cable connection on the Sigma 05 electronics board

When connecting the display’s FFC cable to the Sigma 05 electronics board, please observe the correct orientation. The blue cable stiffener needs to be on the left side as shown in Fig. 8.

6.2 Firmware Update

Connect the Sigma 05 to a PC. Start the PCS10 Product Configuration Software while the PC is connected to the internet, and scan the COM port connected to Sigma 05 as described in chapter 5, point 4. If there is a firmware update available, it will be indicated in the “Information” view of the PCS10. Select the desired update by clicking on it, then proceed by clicking on the “Update firmware” button. Refer also to the help pop-up in the “Information” view.

6.3 Reference Probe

The Reference Probe Modbus RTU (HA010406) facilitates a functional and accuracy check of the Sigma 05 sensor hub. Please refer to the Reference Probe’s Quick Guide at www.epluse.com/Sigma05.



Power off Sigma 05 before connecting or disconnecting sensing or reference probes. Failing to do so may cause damages to Sigma 05 and to the probes.

6.4 Repairs

Repairs may be carried out by the manufacturer only. The attempt of unauthorized repair excludes any warranty claims.

6.5 Error Indication on the Analogue Output (NAMUR)

The Sigma 05 sensor hub features an error indication on the analogue outputs according to the NAMUR NE 043 recommendations (Standardization of the Signal Level for the Failure Information of Digital Transmitters, Edition 2003-02-03, see www.namur.net/en/recommendations-and-worksheets/current-nena.html).

The feature is enabled by factory default and can be disabled and configured with the PCS10 Product Configuration Software.

Output signal	NAMUR signal level
0 - 5 V	5.5 V
0 - 10 V	11 V
0 - 20 mA	21 mA
4 - 20 mA	21 mA

7 Spare Parts

Display for Sigma 05

D09P

For accessories refer to the Sigma 05 data sheet at www.epluse.com/Sigma05 and to the “Accessories” data sheet.

8 Technical Data

Probe connection

Max. number of sensing probes ¹⁾	3
Max. number of measurands	5 (2 on the analogue outputs, 3 on the display)
Probe interface	RS485
Protocol	Modbus RTU
Default settings	Baud rate 9600 ²⁾ , data bits 8, parity even, stop bits 1
Electrical connection	M12x1 socket 5 poles

Outputs

Voltage	0 - 1 V / 0 - 2.5 V / 0 - 5 V / 0 - 10 V	$0 < I_L < 1 \text{ mA}$
Current	0 - 20 mA / 4 - 20 mA (3-wire)	$R_L < 500 \Omega$
<i>Freely selectable and scalable</i>		
Accuracy of analogue outputs at 20 °C (68 °F)	0.02 % FS for 0 - 10 V and 0 - 20 mA	(FS = full scale)

General

Power supply class III  (EU) / class 2 (NA)	15 - 30 V DC
Supply current to the probes, max.	0.5 A
Electrical connection	5 pole spring clamp terminal, max. 2.5 mm ²
Cable feedthrough	Cable gland M16x1.5
Configuration interface	USB-C on the electronics board
Configuration software (free)	PCS10 Product Configuration Software
<i>Free download from www.epluse.com/PCS10</i>	
Enclosure	Polycarbonate, UL94V-0 (with Display UL94HB) approved
Material	IP65/NEMA 4
Protection rating ³⁾	
Electromagnetic compatibility	EN 61326-1:2013 EN 61326-2-3:2013 Industrial Environment FCC Part15 Class A ICES-003 Class A
Working and storage conditions	-40...60 °C (-40...140 °F) without display -20...50 °C (-4...122 °F) with display 0...95 % RH, non-condensing 700...1200 mbar



1) Compatible E+E probes see chapter 3.5 Sensing Probes.

2) Supported baud rates: 9600, 19200, 38400, 57600, 76800 and 115200.

For details on the communication setting refer to the User Manual and the Modbus Application Note at www.epluse.com/Sigma05.

3) With appropriate cable/probe connector (M12x1 socket).



HEADQUARTERS

E+E Elektronik Ges.m.b.H.

Langwiesen 7
4209 Engerwitzdorf
Austria
Tel.: +43 7235 605-0
E-mail: info@epluse.com
Web: www.epluse.com

SUBSIDIARIES

E+E Elektronik China

18F, Kaidi Financial Building,
No.1088 XiangYin Road
200433 Shanghai
Tel.: +86 21 6117 6129
E-mail: info@epluse.cn

E+E Elektronik France

Le Norty III, 136 chemin du Moulin
69130 Ecully
Tel.: +33 4 74 72 35 82
E-mail: info@epluse.fr

E+E Elektronik Germany

Schöne Aussicht 8 C
61348 Bad Homburg
Tel.: +49 6172 13881-0
E-mail: info@epluse.de

E+E Elektronik Italy

Via Alghero 17/19
20128 Milano (MI)
Tel.: +39 02 2707 86 36
E-mail: info@epluse.it

E+E Elektronik Korea

Suite 2001, Heungdeok IT
Valley Towerdong, 13,
Heungdeok 1-ro, Giheung-gu
16954 Yongin-si, Gyeonggi-do
Tel.: +82 31 732 6050
E-mail: info@epluse.co.kr

E+E Elektronik USA

333 East State Parkway
Schaumburg, IL 60173
Tel.: +1 847 490 0520
E-mail: office@epluse.com

YOUR PARTNER IN SENSOR TECHNOLOGY



ELEKTRONIK®
Ges.m.b.H.